

## D-CARD DOWNLOAD

### 1. Connecting SCAN-100 to PC

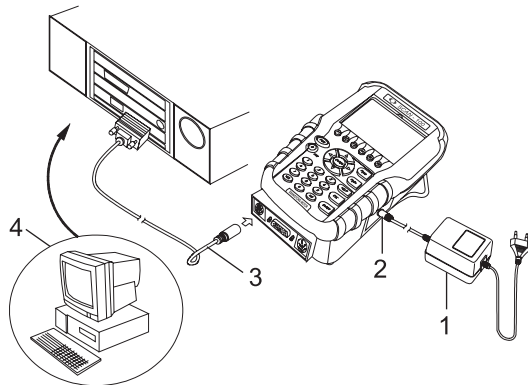

1. AC/DC Power Supply
2. DC Power Jack
3. RS-232 communication cable
4. PC Terminal

### 2. Inserting Program Card into SCAN-100

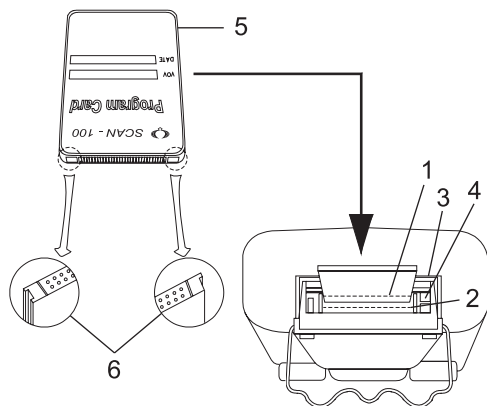

1. Program Card Slot
2. Memory Card Slot
3. Hinged Body
4. Card Eject Button
5. Program Card
6. Notches

1. Inserting program card : Insert the card with label(SCAN-100 program card ver. ) side up and to the direction of arrow. Push this card all the way to the end. And if the card is inserted in a wrong way, the card may not be set in the slot.

2. "PCMCIA" cards and memory capacities.

PCMCIA card is consist of FLASH memory. SCAN-100 has two kinds of PCMCIA card; program card and data memory card.

Program card: This card contains the operation program of SCAN-100.

Data memory card: This is used for recording a traveling data, a wave data, etc.

Capacities of program card: It is able to extend its memory capacity up to 16MByte, and its basic memory is 2MByte.

Capacities of data memory card: It is able to extend its memory capacity up to 10MByte.

### 3. Selecting Download Mode of SCAN-100



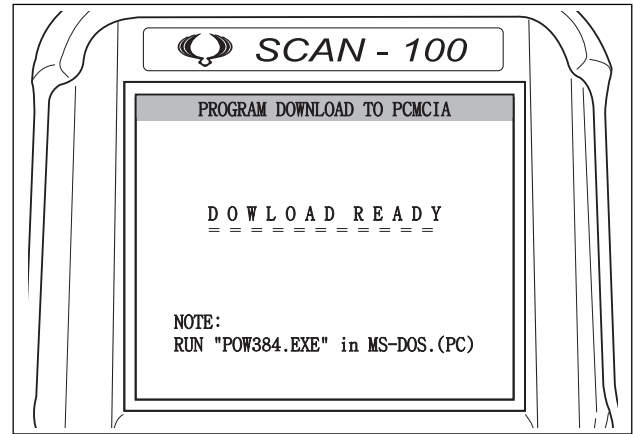



1. Connect communication port of PC to left input port of SCAN-100 by using a download communication cable.
2. Press "PWR" key after pushing a hotkey ("YES" + "NO" + "2").
3. Perform a SCANLOAD program.





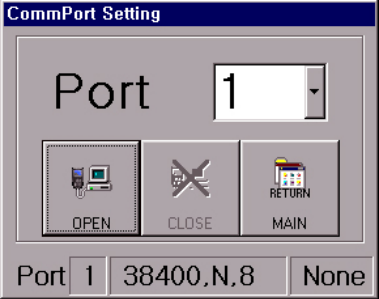
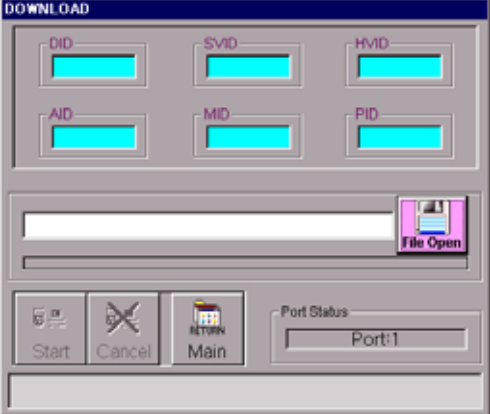

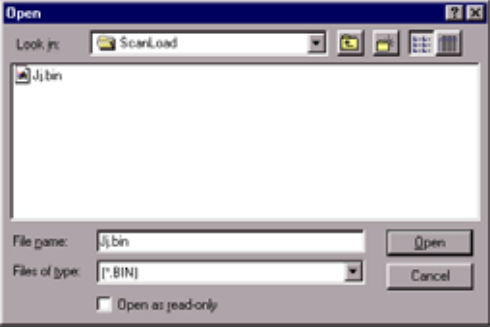

SCAN  
ECU

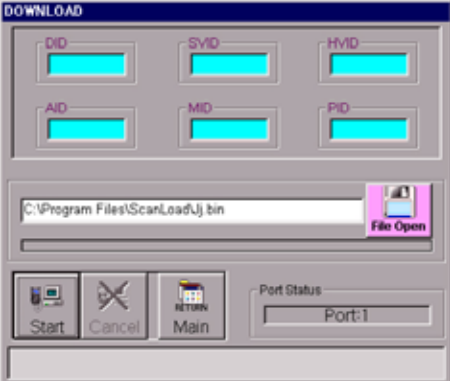
CHANGED BY	
EFFECTIVE DATE	
AFFECTED VIN	

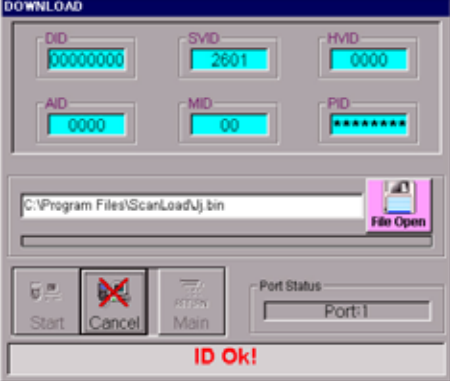
### 4. Perform Scanload

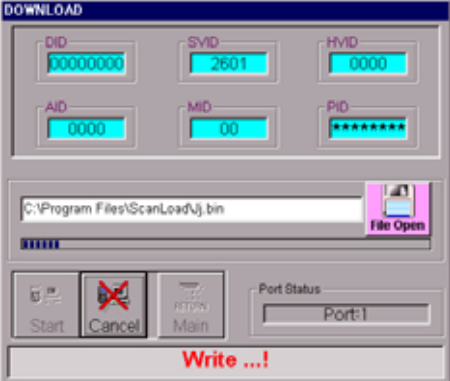
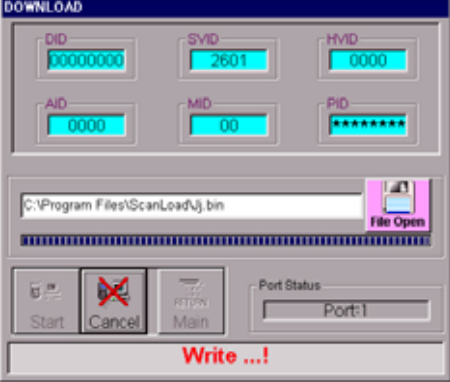
Screen Flow	Description
	 <p>Click the button  , in an initial screen.</p>
	<p>Select the communication port connected to SCAN-100.</p>
	<p>Basic screen of download mode.</p> <p>Click the button  .</p>
	<p>Select a file which you wish to write, and click the button  .</p>

Screen Flow	Description
	<p>Click the button .</p>
	<p>If the ID of a selecting file is same to the SCAN-100's ID, then <b>ID Ok!</b> is indicated. if not, then it shows  message.</p>
	<p>Write a selecting file to program card of SCAN-100.</p>
	<p>If the download is completed,  message.</p> <p>Then you get a  message.</p>

CHANGED BY	
EFFECTIVE DATE	
AFFECTED VIN	